



Commercial
Vehicles

The ABT e-Transporter 6.1



ABT



Developed in collaboration with our Premium Partner ABT e-Line, a company that is considered a pacesetter for electric mobility for both motorsport and road vehicles, we have introduced the ABT e-Transporter 6.1 – our first fully electric van in the UK. Replacing the internal combustion engine with an electric power train has the potential to greatly reduce greenhouse gas emissions on our roads, and with this in mind, the iconic Transporter 6.1 is now available as an all-electric version.

With grants available for purchasing and charge point installation, the potential of lower running and servicing costs and free access to ultra-low emissions zones, these factors can make buying and owning an electric van an attractive choice for you and your business in the future.

Changing urban logistics.



zero emissions
whilst driving.

Image shown is for illustrative purposes only. Vehicle shown features optional front fog lights and 16" wheel trims which are not available in the UK.

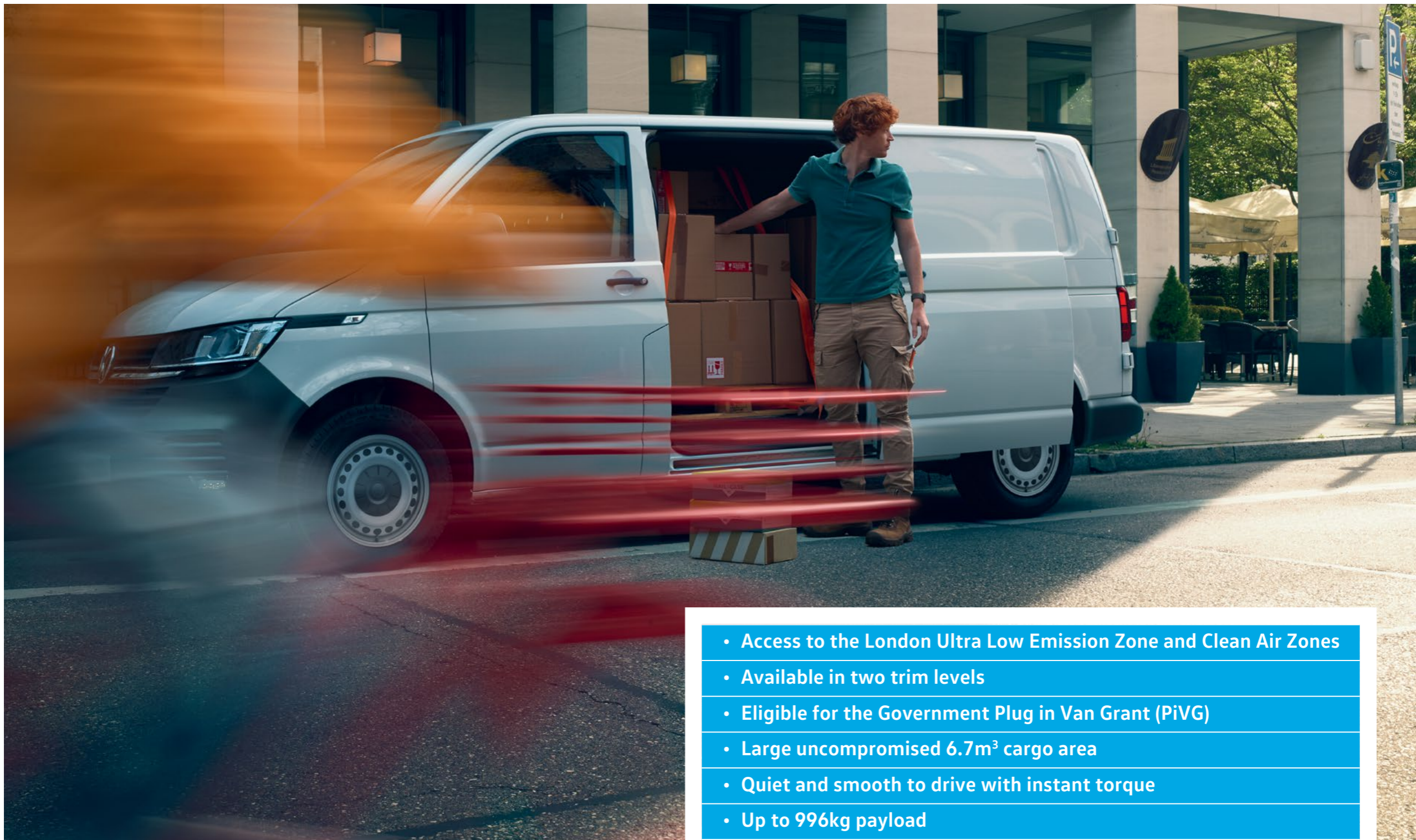

- Access to the London Ultra Low Emission Zone and Clean Air Zones
- Available in two trim levels
- Eligible for the Government Plug in Van Grant (PiVG)
- Large uncompromised 6.7m³ cargo area
- Quiet and smooth to drive with instant torque
- Up to 996kg payload
- Zero emissions whilst driving
- Zero road tax (VED)

Image shown is for illustrative purposes only. Vehicle shown features optional front fog lights.

Power and **efficiency.**



Power meter.

The usual rev counter dial in the driver's instrument cluster is replaced with a power meter that includes a charge level indicator. When the needle is in the green, the battery is being charged by recuperation during braking. The blue area denotes the typically optimum speeds and acceleration for the most economical driving and in addition, thanks to the charge level indicator, you always have the current state of charge in the battery. The energy consumption and the remaining range can also be shown on the multi-function display.

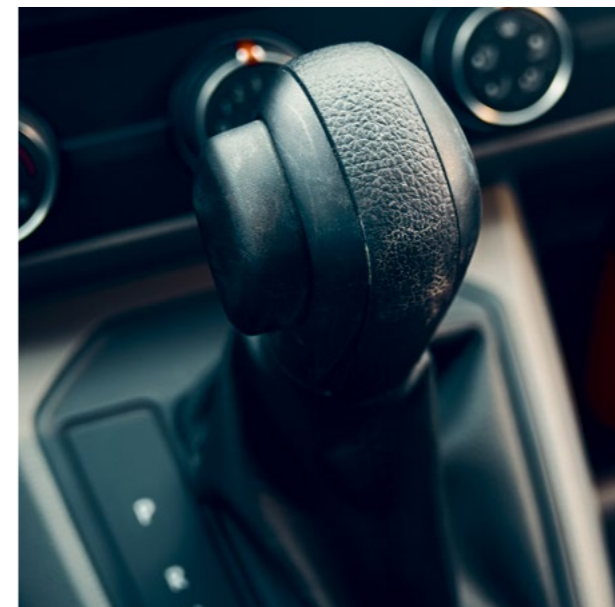

Modified dual clutch transmission DSG.

Taking the advantages of the conventional dual clutch transmission DSG and combining it with the requirements of electric drive, the ABT e-Transporter 6.1 develops sufficient power in any driving situation. Like in a normal ICE, using the gear shift you can select Park 'P', Reverse 'R' and Drive 'D'. Driving in 'D' provides you with 75% power and torque therefore maximising the range, the kickdown function delivers 100% power and torque, maximising performance.

Image shown is for illustrative purposes only. Vehicles shown may not reflect UK specification.

01 Battery.

The compact battery is designed to provide more than 1,600 charging cycles and consists of 16 modules that can be individually replaced. In addition, the cargo area is not compromised, as the compact batteries of the ABT e-Transporter 6.1 are fitted below the load area.

37.3 kWh
lithium-ion battery

02 Recuperation.

Recuperation is the recovery of energy usually lost when braking. On the ABT e-Transporter 6.1, this is achieved by changing the drive motor to generator operation and feeding the resulting current into the vehicle's battery, where it is stored for later use.



03 Electric motor.

A technically advanced and lightweight electric motor replaces the conventional internal combustion engine in the ABT e-Transporter 6.1. The compact motor is extremely quiet and requires lower maintenance while providing instant torque.

range of up to
82 miles*

cargo space of
6.7 m³

max. power
110 PS (83kW)

04 Power electronics.

The power electronics provide the central component of the electric drive. It provides connection to the high-voltage battery and supplies the on-board electronics and the electric motor with energy.

* Figures shown are for comparability purposes and were obtained after the battery had been fully charged. Mains electricity required for charging. Only compare electric range figures with vehicles tested to the same technical procedures. Figures may not reflect real life driving results.

Charge up.

Combined Charging System (CCS).

The CCS socket on the ABT e-Transporter 6.1 provides a flexible charging solution, combining the ability to charge via either AC or DC. This means you can use any chargepoint that has either a CCS (DC charging – cable not supplied) or Type 2 (AC charging) plug type. A 5m Type 2 charging cable is included with the vehicle as standard.



* Actual charge times may vary depending on the age, type, condition and temperature of the charger and the battery, as well as the ambient temperature at the point of use and other factors. Charge times will be longer if battery temperature activates safeguarding technology.

Wallbox.

A wallbox is designed to provide a more efficient charging performance and consequently shorter charging time than a normal domestic mains socket. A 7.2kW wallbox will charge the lithium-ion battery from 0-100% in approximately five and a half hours*. For more information regarding wallboxes or to discuss what the right charging infrastructure is for your business, please contact your local authorised Volkswagen Van Centre, who will be happy to advise you.



DC charging.

Rapid charging using a DC charger is the fastest way to charge your electric van. The ABT e-Transporter 6.1 supports up to 50kW DC charging using a CCS connector, which means the vehicle's lithium-ion battery can be charged from 0-80% in approximately 45 minutes*.



AC charging.

The ABT e-Transporter 6.1 can support AC charging up to 7.2kW. This can be done either by using a wallbox or by plugging into a standard UK 3-pin mains socket (cable not supplied). We recommend using a wallbox to charge your van due to the high energy demands and the significantly faster charge time.



* Actual charge times may vary depending on the age, type, condition and temperature of the charger and battery, as well as the ambient temperature at the point of use as well as other factors. Charge times will be longer if battery cell temperature activates safeguarding technology.

Build your own

Find a Van Centre

Test drive

Offers & Finance

Conversions



Model pricing and specifications.

Image shown is for illustrative purposes only. Vehicle shown features optional front fog lights and 16" wheel trims which are not available in the UK.

*Manufacturer's recommended on the road (OTR) package.	
Delivery to Van Centre	£620.00
Number plates	£20.00
VAT	£128.00
First registration fee	£55.00
Vehicle excise duty (VED) 1st year	£0.00
Basic OTR price (exc. VAT)	£695.00
Total OTR price (inc. VAT)	£823.00

Volkswagen Commercial Vehicles may change RRP's at any time (this includes where there are government changes in regulation and/or legislation). There may be a delay to any RRP displaying correctly on our materials. Always obtain prices from your chosen authorised Van Centre.

The ABT e-Transporter 6.1

Model pricing and specifications

Technical information

Optional equipment

Finance, insurance, servicing and warranties

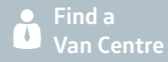
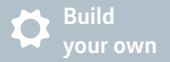

ABT e-Transporter 6.1

Model prices†

Trimline	Fuel type	Basic exc. VAT	Total inc. VAT	Total RRP inc. OTR ¹ exc. VAT	Total RRP inc. OTR inc. VAT, excl. PIVG ²	Total RRP inc. OTR inc. VAT with PIVG ² deducted
ABT e-Transporter 6.1 Panel van	Electric	£41,365.00	£49,638.00	£42,060.00	£50,461.00	£44,461.00
ABT e-Transporter 6.1 Panel van Advance	Electric	£44,665.00	£53,598.00	£45,360.00	£54,421.00	£48,421.00
ABT e-Transporter 6.1 kombi crew van	Electric	£45,680.00	£54,816.00	£46,375.00	£55,639.00	£49,639.00
ABT e-Transporter 6.1 kombi crew van Advance	Electric	£49,290.00	£59,148.00	£49,985.00	£59,971.00	£53,971.00

1 Please [click here](#) for more details on manufacturer's on the road (OTR) package.

2 The Plug In Vehicle Grant is a grant currently offered by the Office for Zero Emission Vehicles (OZEV) to eligible manufacturers to promote the purchase of zero emission vehicles. As of 18 March 2021 the government announced changes to the Plug-in Van Grant (PIVG) that will affect the ABT e-Transporter 6.1 that currently qualifies for this scheme. Customers purchasing a ABT e-Transporter 6.1 will receive 35% off the purchase price up to a maximum of £6,000. The £6,000 grant has already been deducted from the recommended 'On the road' price shown (and therefore the recommended 'On the road' price will increase in the event that grant funding is withdrawn, or eligibility for the grant or the grant amount changes, for any reason). Your authorised Volkswagen Van Centre will submit the details of your order online in order to claim the grant funding. The grant is subject to full T&Cs and eligibility requirements. For more information, please contact your authorised Volkswagen Van Centre or visit www.gov.uk/plug-in-car-van-grants/overview. The Government Plug-in Van Grant (PIVG) is not applicable to sales in the Channel Islands or Isle of Man. Vehicle eligibility and grant figure correct as at 18.3.2020.

Volkswagen Commercial Vehicles may change RRP's at any time (this includes where there are government changes in regulation and/or legislation). There may be a delay to any RRP displaying correctly on our materials. Always obtain prices from your chosen authorised Van Centre.

The ABT e-Transporter 6.1

Model pricing and specifications

Technical information

Optional equipment

Finance, insurance, servicing and warranties

ABT e-Transporter 6.1 Panel van

Starting from **£41,365†**

Please click here for more details.

Standard equipment

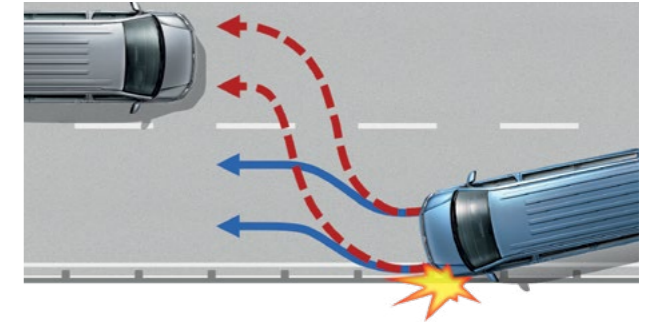
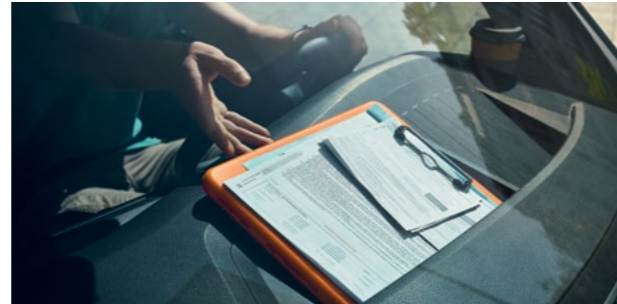

WHEELS

- 16 inch steel wheels 205/65 R16 tyres with low rolling resistance
- Steel spare wheel
- Tool kit and jack

EXTERIOR

- Electrically adjustable and heated exterior door mirrors
- Grey bumpers with exterior door mirror housings and door handles in Black
- H7 twin halogen headlights
- Radiator grille with double chrome trim strip

AIR CONDITIONING AND SUN PROTECTION

- Climatic air conditioning system
- Heat-insulating windows in cab

DRIVER'S WORKPLACE

- Dash panel with open stowage compartments, drink holders and illuminated lockable glovebox
- Dimmable dashboard illumination
- 'Double Grid' cloth seat upholstery in Titanium Black
- Driver's seat with armrest, height adjustment and 4-way manual lumbar support
- Dual passenger bench seat
- Durable rubber floor in the cab
- Electric windows in the cab
- Heated front seats
- Folding grab handles on roof frame
- Leather trimmed multi-function steering wheel with height and longitudinal adjustment
- LED interior lighting with two reading lights in the roof console
- Sun visors and airbag label on front passenger sun visor
- 12V socket

INFOTAINMENT AND CONNECTIVITY

- Composition Colour DAB+ radio system with 6.5 inch touchscreen and four loudspeakers, SD card slot, Bluetooth® hands-free and two USB interfaces (type-C) in dashboard
- Multi-function display 'Premium' with colour display
- Volkswagen App-Connect

LOAD COMPARTMENT

- Folding lashing rings for load restraint system, reinforced (ISO 27956)
- Full height steel bulkhead, without window
- Half-height side trim panels and roof trim panels made of hardboard
- Interior lighting with LED technology in load compartment
- Rear wing doors without window apertures
- Sliding door on the left in load compartment

DRIVER ASSISTANCE, SAFETY AND SECURING SYSTEMS

- Acoustic Vehicle Alert System
- Automatic Post-Collision Braking System¹
- Brake Assist system
- Central locking system with two remote control folding keys and interior operation
- Crosswind Assist¹
- Daytime running lights
- Driver Alert system
- Driver and front passenger airbags with front passenger's airbag deactivation button
- Electromechanical steering
- Electronic Stabilisation Programme² (ESP), Anti-lock Braking System (ABS), Traction Control System (ASR), Electronic Differential Lock (EDL) and Hill Start Assist¹
- Engine immobiliser
- Front Assist with City Emergency Braking System¹
- Parking sensors, rear
- Regenerative braking
- Single-tone horn

ABT e-Transporter 6.1 kombi crew van

Starting from **£45,680†**

Please click here for more details.

Standard equipment in addition to panel van

- Dimmable interior rear-view mirror
- Full height side trim panels in the load compartment
- Illuminated steps in load/passenger compartment
- ISOFIX and top tether child seat anchors for the outer seats of the three-seater bench seat

- Rear window in tailgate with heat-insulating glass, heated with wiper and washer system
- Rubber floor covering in the passenger compartment with loading edge protection in rear
- Side sliding windows in the second row, left and right

- Tailgate closing with unlatching from the inside
- Two individual seats at the front and a folding three-seater bench seat at the rear in the second row
- Tyre pressure loss indicator

¹ Within the system's thresholds. Images shown are for illustrative purposes only. Vehicles shown may not reflect UK specification. Volkswagen Commercial Vehicles may change RRP's at any time (this includes where there are government changes in regulation and/or legislation). There may be a delay to any RRP displaying correctly on our materials. Always obtain prices from your chosen authorised Van Centre. † Basic RRP excluding VAT.

Detailed information regarding tyre efficiency labelling and technical specifications on all potential tyre fitments can be found by visiting the Volkswagen Commercial Vehicles online car configurator at www.volkswagen-vans.co.uk/en/configurator.html

ABT e-Transporter 6.1 Panel van Advance

Starting from **£44,665†**

Please click here for more details.

Equipment (in addition to Base)



WHEELS

17 inch 'Devonport' alloy wheels 7J x 17.
In Silver with 215/60 R17 tyres
Lockable wheel bolts

EXTERIOR

Automatic headlight activation with separate daytime running lights, leaving home and manual coming home function
Body-coloured exterior door mirror housings, door handles and bumpers
Electrically foldable exterior door mirrors
Front fog lights with cornering function
LED headlights with separate LED daytime running lights
Windshield wiper intermittent control with rain sensor

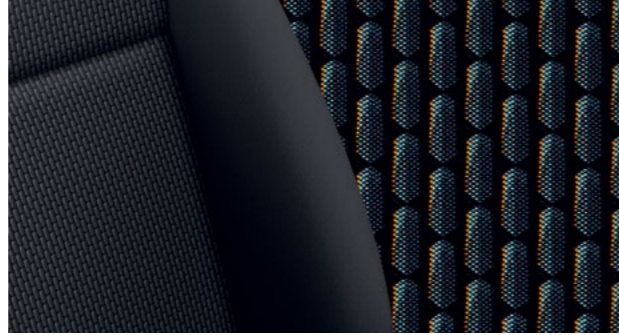

DRIVER'S WORKPLACE

Additional 12V socket in dashboard
Auto-dimming interior rear-view mirror
'Bricks' cloth seat upholstery in Titanium Black
Entry handle on A-pillar on driver's and front passenger's side
One waste bin in door storage compartment
Sun visors with mirror and airbag label on front passenger sun visor



AIR CONDITIONING AND SUN PROTECTION

Laminated windshield, heated



DRIVER ASSISTANCE, SAFETY AND SECURING SYSTEMS

Parking sensors, front and rear
High beam control
Anti-theft alarm system with interior monitoring in cab, backup horn, towing protection and SAFELOCK



ABT e-Transporter 6.1 kombi crew van Advance

Standard equipment in addition to panel van

Armrests for both front seats
Manual height adjustment for both front seats
Manually adjustable lumbar support for both front seats
Privacy glass from the B-pillar, heat-insulating glass (green) in front

Starting from **£49,290†**

Please click here for more details.

1 Within the system's thresholds. Images shown are for illustrative purposes only. Vehicles shown may not reflect UK specification. Volkswagen Commercial Vehicles may change RRP's at any time (this includes where there are government changes in regulation and/or legislation). There may be a delay to any RRP displaying correctly on our materials. Always obtain prices from your chosen authorised Van Centre. † Basic RRP excluding VAT.

Detailed information regarding tyre efficiency labelling and technical specifications on all potential tyre fitments can be found by visiting the Volkswagen Commercial Vehicles online car configurator at www.volkswagen-vans.co.uk/en/configurator.html

Technical information

Consumption, performance and emissions†

Trimline/transmission	Output, PS	CO ₂ emission, g/km ¹ WLTP test cycle	Consumption, kWh/62 miles ¹ (100km), Combined	Acceleration, 0 - 62 mph	Top speed, mph (where the law permits)	Range, miles ¹ WLTP	Efficiency class ²
ABT e-Transporter 6.1 Panel van automatic	110	0	28.1	17.4	56	up to 82	A+
ABT e-Transporter 6.1 Panel van Advance automatic	110	0	28.4	17.4	56	up to 82	A+
ABT e-Transporter 6.1 kombi crew van automatic	110	0	28.9	17.4	56	up to 80	A+
ABT e-Transporter 6.1 kombi crew van Advance automatic	110	0	29.1	17.4	56	up to 80	A+

1 These figures were obtained after the battery had been fully charged. The ABT e-Transporter 6.1 is a battery electric vehicle requiring mains electricity for charging. There is a new test for fuel consumption, CO₂ and electric range figures (known as WLTP). The electric range shown was achieved using the new test procedure. Figures shown are for comparability purposes. Only compare fuel consumption, CO₂ and electric range figures with other vehicles tested to the same technical procedures. These figures may not reflect real life driving results, which will depend upon a number of factors including the starting charge of the battery, accessories fitted (post-registration), variations in weather, driving styles and vehicle load. Zero emissions while driving. Data correct at 01.04.2020. Always consult your authorised Volkswagen Van Centre for the latest price and technical information.

2 Efficiency classes assess vehicles according to CO₂ emissions, taking into account the vehicle's unladen weight. Vehicles conforming to that are graded D. Vehicles that are better than today's average are graded A+, A, B or C. Vehicles that are worse than the average are graded E, F or G.

Weights†

Trimline	Gross vehicle weight, kg	Axle load limit, front/rear, kg	Trailer weight braked 12%/ unbraked, kg	Gross train weight, kg	Unladen weight ¹ , kg	Payload ² , kg
ABT e-Transporter 6.1 Panel van	3,200	1,710 / 1,720	1,500 / 750	3,770	2,204	996
ABT e-Transporter 6.1 Panel van Advance	3,200	1,710 / 1,720	1,500 / 750	3,770	2,238	962
ABT e-Transporter 6.1 kombi crew van	3,200	1,710 / 1,720	1,500 / 750	3,770	2,300	900
ABT e-Transporter 6.1 kombi crew van Advance	3,200	1,710 / 1,720	1,500 / 750	3,770	2,323	877

1 Unladen weight includes battery, all coolants, fluids, lubricants and 75kg for driver.

2 Payload = gross vehicle weight minus unladen weight. Quoted weights are for vehicles with standard specification. Unladen weight and payload may be influenced by trimline, factory options and Van Centre fitted accessories. Roof load limit: 100kg (with two roof carriers) or 150kg (with at least four roof carriers) for normal roof only. Trailer nose weight: 100kg.

† Technical information (including fuel consumption, CO₂ emissions, range and weights) is yet to be confirmed. We regularly update specifications so all technical information is subject to change (and this may include changes between order and delivery). There may be a delay in updates showing on our website. Always consult your authorised Volkswagen Van Centre for the latest price and technical information.

Dimensions ABT e-Transporter 6.1

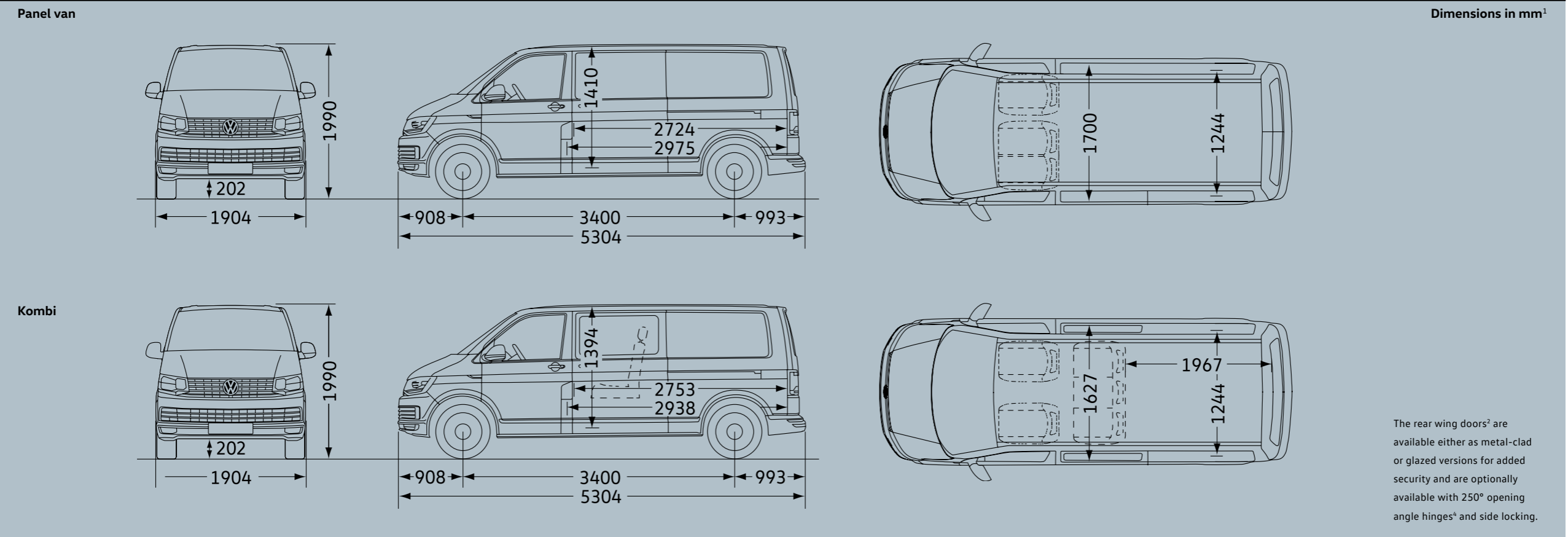

Dimensions	Panel Van	Kombi
Load compartment		
Area in m ²	5.0	5.0
Sliding door		
Width x height in mm ¹	1,017 x 1,282	1,017 x 1,264
Tailgate		
Width x height in mm ¹	1,473 x 1,299	1,473 x 1,290
Wing door		
Width x height in mm ¹	1,473 x 1,299	1,473 x 1,305
Turning circle		
in mm ¹	13,200	13,200
Roof load limit		
in kg (2 roof carriers) / (3 roof carriers)	100 / 150	100 / 150

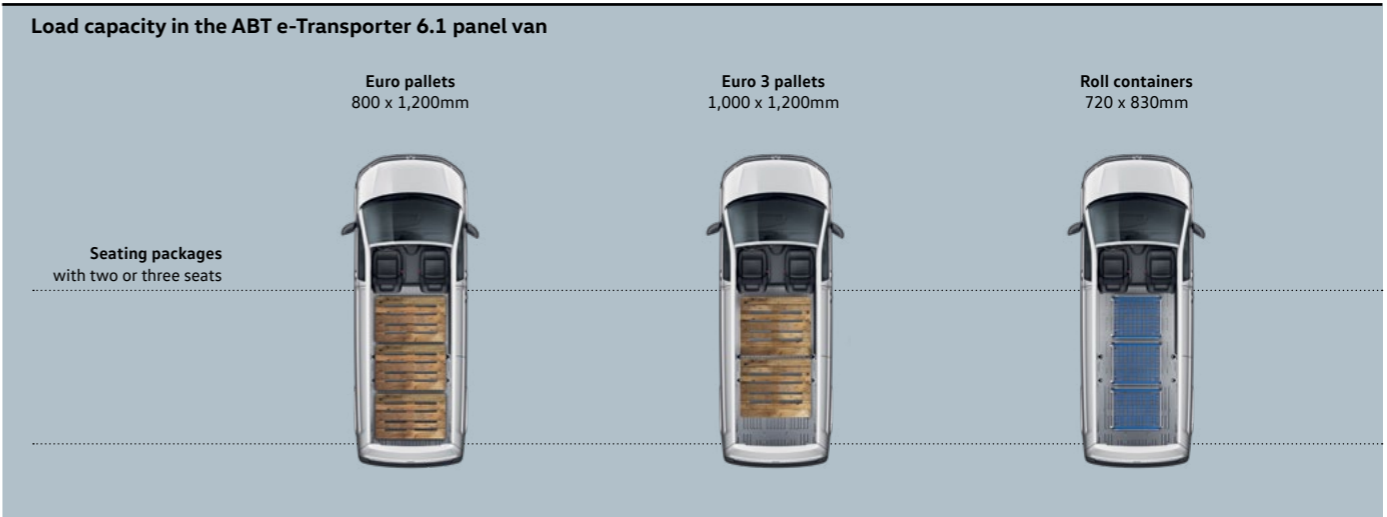

¹ Please note that these are approximate values and the dimensions may differ due to manufacturing tolerances. ² Rear wing doors are standard equipment. ³ Measured at the floor height of the vehicle. ⁴ 250° opening angle hinges are optional on all models. Images shown are for illustrative purposes only. Vehicles shown are not UK specification.



Optional equipment.

Image shown is for illustrative purposes only. Vehicle shown features optional front fog lights and 16" wheel trims which are not available in the UK.

Options – ABT e-Transporter 6.1

ABT e-Transporter 6.1

ABT e-Transporter 6.1 Advance

Paint	PR Code		Basic exc. VAT	Total RRP inc. VAT	Basic exc. VAT	Total RRP inc. VAT
Solid. Bright Orange ¹ (E3E3), Candy White (B4B4), Cherry Red (4B4B), Ascot Grey (6U6U), Pure Grey (J2J2).	As shown	PV/K	○	○	○	○
Metallic. Bay Leaf Green (C4C4), Fortana Red (I9I9), Indium Grey (X3X3), Mojave Beige (1B1B), Starlight Blue (3S3S), Copper Bronze (5A5A), Ravenna Blue (5Z5Z), Reflex Silver (8E8E).	As shown	PV/K	£635.00	£762.00	£635.00	£762.00
Pearl effect. Deep Black (2T2T).	As shown	PV/K	£635.00	£762.00	£635.00	£762.00

Upholstery

Seat trim covers in Titanium Black 'Double Grid' cloth. Dashboard upper in Titanium Black, dashboard lower in Palladium, floor covering in Titanium Black.	NOA/PX	PV/K	●	●	–	–
Seat trim covers in Titanium Black 'Bricks' cloth. Dashboard upper in Titanium Black, dashboard lower in Palladium, floor covering in Titanium Black.	NOE/PX	PV/K	–	–	●	●
Seat trim covers in Palladium 'Robusta' cloth.² Dashboard upper in Titanium Black, dashboard lower in Palladium, floor covering in Titanium Black.	NOR/GN	PV/K	£125.00	£150.00	£125.00	£150.00
Seat trim covers in Palladium 'Leatherette Mesh'. Dashboard upper in Titanium Black, dashboard lower in Palladium, floor covering in Titanium Black.	N2Q/GN	PV/K	£65.00	£78.00	£65.00	£78.00

● Standard – Not available ○ At no extra cost

Where additional equipment is required by chosen options, this will be at additional cost. See the relevant option for recommended pricing or consult your local authorised Van Centre.

1 Bright Orange is not available on ABT e-Transporter 6.1 Advance.

2 Only available for the driver and front passenger seats. For kombi crew vans, second row of seats will be supplied in 'Mesh' leatherette.

PV Panel van K Kombi

Volkswagen Commercial Vehicles may change RRP's at any time (this includes where there are government changes in regulation and/or legislation). There may be a delay to any RRP displaying correctly on our materials. Always obtain prices from your chosen authorised Van Centre.

Options – ABT e-Transporter 6.1 (continued)

Seating	PR Code		ABT e-Transporter 6.1		ABT e-Transporter 6.1 Advance	
			Basic exc. VAT	Total RRP inc. VAT	Basic exc. VAT	Total RRP inc. VAT
Armrest for driver's seat.	4S3	PV/K	●	●	●	●
Armrest for both front seats. Only in combination with the single front passenger seat (3TH).	4S1	PV	£80.00	£96.00	£80.00	£96.00
		K	£80.00	£96.00	●	●
Dual passenger seat in cab.	3TJ	PV	●	●	●	●
		K	£215.00	£258.00	£215.00	£258.00
Heated driver and front passenger seats. Separately controllable. Only in combination with either Climatic cab A/C, Climatic cab A/C with manual passenger heating, Climatic cab and passenger A/C (semi-automatic) with manual passenger compartment heating system at additional cost.	4A3	PV/K	●	●	●	●
Height-adjustment (manual) and lumbar support (manual) for driver and single front passenger seats. Only in combination with single front passenger seat.	7P4/3L3	PV	£105.00	£126.00	£105.00	£126.00
		K	£105.00	£126.00	●	●
Single front passenger seat. For panel van models. Only in combination with armrest for driver and front passenger seats 4S1 at an additional cost. Only in combination with height-adjustment (manual) 3L3 and lumbar support (manual) 7P4 for driver and single front passenger seats at no additional cost.	3TH	PV	○	○	○	○
		K	●	●	●	●

● Standard – Not available ○ At no extra cost

Where additional equipment is required by chosen options, this will be at additional cost. See the relevant option for recommended pricing or consult your local authorised Van Centre.

PV Panel van K Kombi

Volkswagen Commercial Vehicles may change RRP's at any time (this includes where there are government changes in regulation and/or legislation). There may be a delay to any RRP displaying correctly on our materials. Always obtain prices from your chosen authorised Van Centre.

Options – ABT e-Transporter 6.1 (continued)

	PR Code		ABT e-Transporter 6.1		ABT e-Transporter 6.1 Advance	
			Basic exc. VAT	Total RRP inc. VAT	Basic exc. VAT	Total RRP inc. VAT
Wheels and tyres						
17" Devonport alloy wheels. 7J x 17. Four alloys.	Z3F/Q32	PV/K	–	–	●	●
All-weather tyres. Please contact your local Van Centre for availability on specific models.	Q31/Q33	PV/K	From £135.00	From £162.00	From £135.00	From £162.00
Wheel and tyre accessories						
Tyre mobility kit in lieu of spare wheel. Includes 12V compressor and tyre sealant.	1G8	PV/K	○	○	○	○
Body and chassis						
Electric sliding door driver and passenger's side.	PT4	K	£980.00	£1,176.00	£980.00	£1,176.00
Exterior mirrors, power folding.	6XP	PV/K	£140.00	£168.00	●	●
Manual side sliding door, driver's side.	5R2	PV/K	£660.00	£792.00	£660.00	£792.00
Power latching for sliding door, driver's side. Includes cost of additional sliding door on driver's side.	5R7	PV/K	£790.00	£948.00	£790.00	£948.00
Power latching for sliding door, passenger's side.	5Q7	PV/K	£135.00	£162.00	£135.00	£162.00
Rear wing doors with 250° hinges.	5V4	PV/K	£350.00	£420.00	£350.00	£420.00

● Standard – Not available ○ At no extra cost

Where additional equipment is required by chosen options, this will be at additional cost. See the relevant option for recommended pricing or consult your local authorised Van Centre.

Detailed information regarding tyre efficiency labelling and technical specifications on all potential tyre fitments can be found by visiting the Volkswagen Commercial Vehicles online car configurator at www.volkswagen-vans.co.uk/en/configurator.html

PV Panel van K Kombi

Volkswagen Commercial Vehicles may change RRP's at any time (this includes where there are government changes in regulation and/or legislation). There may be a delay to any RRP displaying correctly on our materials. Always obtain prices from your chosen authorised Van Centre.

Options – ABT e-Transporter 6.1 (continued)

Body and chassis (continued)	PR Code		ABT e-Transporter 6.1		ABT e-Transporter 6.1 Advance	
			Basic exc. VAT	Total RRP inc. VAT	Basic exc. VAT	Total RRP inc. VAT
Mounting rails on the roof (preparation for removable roof rack).	3S4	PV/K	£115.00	£138.00	£115.00	£138.00
Mudflaps.	6N2	PV/K	£135.00	£162.00	£135.00	£162.00
Rear wing doors with heated windows.	ZH1	K	£185.00	£222.00	£185.00	£222.00
Tailgate without window.	3RB	PV	○	○	○	○
	ZH6	K	○	○	○	○
Tailgate without window, power latching.	3RH	PV	£55.00	£66.00	£55.00	£66.00
Tailgate with heated rear window.	ZH7	PV	○	○	○	○
		K	●	●	●	●
Tailgate with window, electric.	ZEH	K	£590.00	£708.00	£590.00	£708.00
Tailgate with window, power latching.	3RJ	PV	–	–	£135.00	£162.00
		K	£135.00	£162.00	£135.00	£162.00
Tow bar preparation (including trailer stabilisation).	1D7	PV/K	£220.00	£264.00	£220.00	£264.00
Tow bar removable/lockable (including trailer stabilisation).	1D2	PV/K	£640.00	£768.00	£640.00	£768.00
Without Transporter badge on rear.	ONA	PV/K	○	○	○	○

● Standard – Not available ○ At no extra cost

Where additional equipment is required by chosen options, this will be at additional cost. See the relevant option for recommended pricing or consult your local authorised Van Centre.

PV Panel van K Kombi

Volkswagen Commercial Vehicles may change RRP's at any time (this includes where there are government changes in regulation and/or legislation). There may be a delay to any RRP displaying correctly on our materials. Always obtain prices from your chosen authorised Van Centre.

Options – ABT e-Transporter 6.1 (continued)

Comfort and convenience	PR Code		ABT e-Transporter 6.1		ABT e-Transporter 6.1 Advance	
			Basic exc. VAT	Total RRP inc. VAT	Basic exc. VAT	Total RRP inc. VAT
Carpet floor covering in cab.	5AE	PV/K	£95.00	£114.00	£95.00	£114.00
Front fog lights with cornering function.	8WH	PV/K	£355.00	£426.00	●	●
High Beam Assist.	8G1	PV/K	-	-	●	●
LED headlights with LED daytime running lights and LED tail lights. Only in combination with a tailgate on Advance.	PXE	PV	-	-	£155.00	£186.00
		K	-	-	●	●
LED headlights with separate LED daytime running lights.	PXH	PV	-	-	●	●
Tyre pressure loss indicator.	7K1	PV	£55.00	£66.00	£55.00	£66.00
		K	●	●	●	●
Tyre pressure monitoring system. Visual display of each tyre pressure is shown in the Multi-function display.	7K3	PV/K	£145.00	£174.00	£145.00	£174.00
Washer fluid level indicator and heated washer nozzles.	8W4	PV/K	£45.00	£54.00	£45.00	£54.00
Driver assistance						
Parking sensors, rear.	7X1	PV/K	●	●	-	-
Parking sensors, front and rear.	7X2	PV/K	£200.00	£240.00	●	●
Parking sensors, front and rear with Park Assist. Only in combination with a tailgate on Advance.	7X5	PV/K	£480.00	£576.00	£285.00	£342.00
Speed limiter, 56 mph.	-	PV/K	●	●	●	●
Speed limiter, 75 mph.	W44	PV/K	£200.00	£240.00	£200.00	£240.00

● Standard – Not available ○ At no extra cost

Where additional equipment is required by chosen options, this will be at additional cost. See the relevant option for recommended pricing or consult your local authorised Van Centre.

PV Panel van K Kombi

Volkswagen Commercial Vehicles may change RRP's at any time (this includes where there are government changes in regulation and/or legislation). There may be a delay to any RRP displaying correctly on our materials. Always obtain prices from your chosen authorised Van Centre.

Options – ABT e-Transporter 6.1 (continued)

Packs	PR Code	ABT e-Transporter 6.1		ABT e-Transporter 6.1 Advance		
		Basic exc. VAT	Total RRP inc. VAT	Basic exc. VAT	Total RRP inc. VAT	
Comfort Pack. Includes an additional 12V socket in the dashboard, one waste bin, additional sound deadening and noise suppression measures, grab handles on A-pillar, folding grab handles on B-pillar and sun visors with mirrors.	ZA9	PV	£250.00	£300.00	●	●
Exterior Pack. Includes body-coloured bumpers, exterior door mirror housings and door handles.	PL4	PV/K	£690.00	£828.00	●	●
Heating and ventilation						
Electronically controlled air conditioning system.	KH6	PV/K	●	●	●	●
Safety and security						
Anti-theft alarm system with interior monitoring in cab, back-up horn and tow-away protection.	Z4G	PV/K	£275.00	£330.00	●	●
First aid kit with warning triangle and safety vest.	1T9	PV/K	£50.00	£60.00	£50.00	£60.00
Four remote control folding keys. Two additional remote folding keys. Only for vehicles without a bulkhead.	8QM	PV/K	£100.00	£120.00	£100.00	£120.00
Cargo area						
Bulkhead, full with fixed window.	ZZ3	PV	£120.00	£144.00	£120.00	£144.00
Rubber floor covering in passenger/load compartment with rear loading edge protection and step illumination.	ZU2	PV	£195.00	£234.00	£195.00	£234.00

● Standard – Not available ○ At no extra cost

Where additional equipment is required by chosen options, this will be at additional cost. See the relevant option for recommended pricing or consult your local authorised Van Centre.

PV Panel van K Kombi

Volkswagen Commercial Vehicles may change RRP's at any time (this includes where there are government changes in regulation and/or legislation). There may be a delay to any RRP displaying correctly on our materials. Always obtain prices from your chosen authorised Van Centre.

Options – ABT e-Transporter 6.1 (continued)

Windows	PR Code	ABT e-Transporter 6.1		ABT e-Transporter 6.1 Advance		
		Basic exc. VAT	Total RRP inc. VAT	Basic exc. VAT	Total RRP inc. VAT	
Rear heated window with window wiper and washer system. Only in combination with a tailgate.	4HS	PV	£140.00	£168.00	£140.00	£168.00
Window in front and closed side panel in rear, in passenger/load compartment on driver's side. Removes sliding function.	4JT	K	○	○	○	○
Window in front and closed side panel in rear, in passenger/load compartment on passenger's side. Removes sliding function.	4FT	K	○	○	○	○
Converter options						
Additional 12V socket in dashboard.	EU1	PV/K	£55.00	£66.00	●	●
Basic CFCU with terminal block.	IS2	PV/K	£415.00	£498.00	£415.00	£498.00
Second battery (68 Ah, AGM) with cut-off relay and battery monitoring. Only in combination with dual passenger seat 3TJ and multi-function control module with electric interface IS2.	8FL	PV/K	£280.00	£336.00	£280.00	£336.00
Second battery (75Ah, AGM) with cut-off relay and battery monitoring. Only in combination with single front passenger seat 3TH and multi-function control module with electric interface IS2.	8FE	PV/K	£300.00	£360.00	£300.00	£360.00

● Standard – Not available ○ At no extra cost

Where additional equipment is required by chosen options, this will be at additional cost. See the relevant option for recommended pricing or consult your local authorised Van Centre.

PV Panel van K Kombi

Volkswagen Commercial Vehicles may change RRP's at any time (this includes where there are government changes in regulation and/or legislation). There may be a delay to any RRP displaying correctly on our materials. Always obtain prices from your chosen authorised Van Centre.



Finance, insurance, servicing and warranties

Finance and insurance.¹

When it comes to paying for your van, we've got options including Contract Hire and Finance Lease, or Hire Purchase. We can also offer you competitive insurance with lots of features and benefits as standard.

A choice of packages.²

Whether you prefer to lease your vehicles, with none of the concerns of ownership and the freedom to change models easily, or purchase outright to own the vehicle that's perfect for your business, we're here to help you consider your options.

You can go flexible, by choosing a payment plan that suits your finances, with options to reduce your monthly costs and your repayment period. Or choose a fixed monthly price that allows you to budget confidently for the longer term.

You can even include your road tax and servicing costs to arrive at one simple, all-inclusive payment. For more information, pick up a finance brochure, or ask at your Van Centre.

Volkswagen Commercial Vehicle Van Insurance.³

Complimentary Drive Away Insurance

Every new and used Volkswagen Commercial Vehicle comes with five days' complimentary Drive Away Insurance, so you can enjoy your new vehicle from day one. We will also provide you with a quote, giving you the option to purchase annual cover, so you can enjoy the same peace-of-mind for a further twelve months. Please speak to your local Volkswagen Van Centre for further details.

Subject to eligibility. Five days' Drive Away Insurance cannot be used in conjunction with any other insurance offer.

Annual Insurance

Comprehensive van insurance, designed specifically for Volkswagen Commercial Vehicles, to offer you maximum convenience with minimum hassle – just as you'd expect.

If you take out a new Volkswagen Commercial Vehicle Van Insurance policy you will receive the following benefits at no additional cost:

- All repairs are carried out by Volkswagen Commercial Vehicles' Trained Technicians in Volkswagen Commercial Vehicles' Authorised Repairers
- Genuine parts and accessories (excludes windscreen claims)
- Courtesy van while yours is being repaired
- Cover for the full cost of repairs to chips or other small damage to your windscreen
- Up to 90 days' foreign travel cover, when using your van abroad
- Up to £250 cover for personal belongings that are lost or damaged following an accident, fire or theft

For more information or to get a quote, call us on: **0345 877 6355**

We're available Monday to Friday 9am-6pm.

Alternatively, visit: www.insurewithwvcv.co.uk

Volkswagen Commercial Vehicle GAP Insurance.⁴

If your Volkswagen Commercial Vehicle is written off, your motor insurer will usually settle your claim based on the current market value of your vehicle. This could be substantially less than the original value of your vehicle.

Volkswagen Commercial Vehicle GAP (also known as 'Guaranteed Asset Protection') Insurance helps to bridge the payment gap to get you back in a new Volkswagen Commercial Vehicle. Whether you purchase, finance, lease or hire your vehicle, Volkswagen Commercial Vehicle GAP Insurance is available and can be arranged up to 60 days after you have collected your new or used vehicle.

For more information about Volkswagen Commercial Vehicle GAP Insurance, visit: www.insurewithwvcv.co.uk/gap-insurance

Servicing and support.

We're here to keep your business moving, with our range of three award-winning⁵ servicing and maintenance options, as well as free Roadside Assistance. Some exclusions apply. For more detail, please visit: www.volkswagen-vans.co.uk/aftersales

Fixed cost maintenance.

This option is available for vehicles that are less than twelve months old and have covered less than 10,000 miles. It makes budgeting easier by splitting the cost of servicing into fixed monthly payments – whether you want Service only; Service and Maintenance; or Service, Maintenance and Tyres.

Fixed price servicing.⁶

If you can pay for more than one service upfront, we'll help by reducing your costs. Buy two upfront and you'll receive one interim and one full service at a discounted rate. Buy four and you'll receive two interim and two full services, with your next MOT also included. You can also spread the cost with monthly payments, helping you budget⁷.

Pay on demand.

If you're looking for freedom and flexibility with your servicing, it's good to know we're ready when you are. So with our third option, you can choose to pay for your services as and when you need them, with our National Service Pricing. Ask your Van Centre for an up-to-date pricing guide.

Roadside Assistance.

We understand the need to keep you mobile. That's why all new vans come with three-year, unlimited mileage roadside cover. Should the unexpected happen, one call gets you straight through to a team trained to help you through any breakdown or accident. Supporting you every day will be a team of vehicle technicians, fully-trained by Volkswagen and carrying the latest diagnostic equipment, specialist tools and parts.

Assistance benefits include:

- Assistance at home, by the roadside or place of work.
- Recovery to your preferred location.
- Onward travel, for you and your cargo.
- Cover 24 hours a day, 365 days a year.
- Free cover for three years (on new vehicles).
- Unlimited mileage.
- European cover.
- Option to extend cover beyond three years.

Warranties.

You can count on us long after you purchase your Transporter, thanks to its comprehensive three-year, 100,000 mile warranty. You choose Volkswagen because your business depends on it, year in, year out. While your Transporter is under warranty, we'll fix any defect in manufacture or workmanship free of charge, even if you purchase and service the vehicle at different Van Centres. Some exclusions apply and the vehicle must be cared for using the guidance in your owner's manual.

For more detail, please visit: www.volkswagen-vans.co.uk/aftersales.

EV eight-year battery warranty.

1. A guarantee for eight years or 100,000 miles (whichever is soonest) with a minimum capacity of 70%, on all material or manufacturing defects.
2. Gradual reduction in battery capacity over times is integral to the nature of the component, and does not represent a defect under the terms of this guarantee, as long as the reduction in capacity is not in excess of the value specified for this vehicle in the owner's manual.
3. With the exception of the warranty term, all warranty conditions stipulated by the Volkswagen dealer selling the vehicle (prerequisites, criteria for freedom from defects, exclusions, settlement of claims, entry into force and start of extended warranty term, scope of application etc.) also apply to the high voltage battery.

Extended warranty.

You can also extend your warranty beyond the three-year, 100,000 mile period, choosing either Comprehensive or Major Component cover, as a one-off or monthly payment.

For more detail of cover levels, along with terms and conditions, please visit: www.volkswagencvwarranty.co.uk where you'll also be able to obtain a quote and purchase an extended warranty.

Paint and body warranty.

Your Transporter's exterior paintwork is covered against manufacturing defects for a period of three years, while its body sections and panels are covered against rusting through from the inside for twelve years. Some exclusions apply and the vehicle must be cared for using the guidance in your owner's manual.

EV vehicle home charging.

Home charging using a domestic socket will depend on the condition and suitability of the wiring in your home. Always consult a qualified electrician before charging when using a domestic socket for the first time, or, if the socket is to be used as the primary source of charging. Domestic sockets on the same circuit as other appliances, particularly those in frequent use, will draw additional amperage which may result in a breaker switch being 'tripped'. Establishing a separate circuit for home charging will help ensure your electric vehicle is supplied with a consistent, uninterrupted current. For optimum charging, we recommend installing an electric vehicle charging point at home.

The Van Centre network.

Our **dedicated Van Centre network** is at the core of everything we do and is always there to help. As a separate brand within the Volkswagen Group, it makes sense to make use of your nearest Van Centre – it's full of experts who understand your vehicle better than anyone else and can help you to get the most out of it.

Over **65 Van Centres** and **30 Authorised Repairers**, means you're only around 45 minutes on average from our door.

1 Volkswagen Commercial Vehicles Insurance and Volkswagen Commercial Vehicle Financial Services are trading names of Volkswagen Financial Services (UK) Limited, Brunswick Court, Yeomans Drive, Blakelands, Milton Keynes MK14 5LR, which is authorised and regulated by the Financial Conduct Authority (FCA). Registered in England and Wales number: 2835230. Volkswagen Financial Services (UK) Limited financial services register number is 311988.

2 An offer of finance depends on certain conditions. Finance subject to status. Available to 18s and over. Terms and conditions apply. Volkswagen Commercial Vehicle Financial Services.

3 Volkswagen Commercial Vehicle Insurance is arranged by U K Insurance Business Solutions Limited and is underwritten by U K Insurance Limited. Calls may be recorded. Volkswagen Commercial Vehicle Financial Services is a trading name of Volkswagen Financial Services (UK) Limited ('VWFS UK'). Registered office: Brunswick Court, Yeomans Drive, Blakelands, Milton Keynes MK14 5LR. Volkswagen Insurance Service (Great Britain) Limited is an appointed representative of VWFS UK. VWFS UK is authorised and regulated by the Financial Conduct Authority. VWFS UK and U K Insurance Limited are not part of the same corporate group.

4 Volkswagen Commercial Vehicle GAP Insurance is administered by Abraxas Insurance Administration Services and underwritten by MAPFRE Asistencia Compañía Internacional de Seguros y Reaseguros, S.A. ('MAPFRE'). VWFS UK is not part of the same corporate group as MAPFRE and Abraxas Insurance Administration Services Limited.

5 Business Vans Awards 2014 and 2015: Best Service Package for Van Owners.

6 Class 4 MOT only. This option is available to all new and used vehicles up to seven years old with no mileage restrictions.

7 Pay monthly option eligible on vehicles with under 200,000 miles at point of activation.

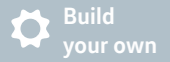

Build
your own



Find a
Van Centre



Test drive



Offers &
Finance



Conversions



The ABT e-Transporter 6.1

This brochure supersedes all previous publications.

Issue: 1 May 2021

www.volkswagen-vans.co.uk

Please note: Screen technology does not allow exact reproduction of the paint and upholstery colours. Some of the vehicles shown are European specification and may be fitted with optional equipment or accessories that are available at extra cost, or do not reflect current specification. All data and specifications are in accordance with information available at the time of publication and are subject to change without notice. Vehicles not currently in UK stock and customer order vehicles may take a number of weeks for delivery. Certain combinations of vehicle specifications and factory-fitted options are not compatible and therefore all orders received are subject to confirmation. Models, factory fitted-options and paint and upholstery options are subject to availability. Please check details and availability with an authorised Volkswagen Van Centre at the time of ordering.